

- ▲ Thirty-six models of fenders to fit most applications.
- ▲ Twelve different designs to cover your various needs.
- ▲ Stocked in most Merritt warehouse locations.
- ▲ Different styles and materials to choose from, allowing you to pick the "look" you want.
- ▲ Aluminum available in .090, .100DP or .125 thickness.
- ▲ 304 16ga stainless steel, #8 polish for strength and bright finish.
- ▲ Design a mounting style that will work for your truck.
- ▲ Custom lengths are available.
- ▲ Use the E-Z Mount Fender Bracket to install.

ALUMINUM & STAINLESS FENDERS

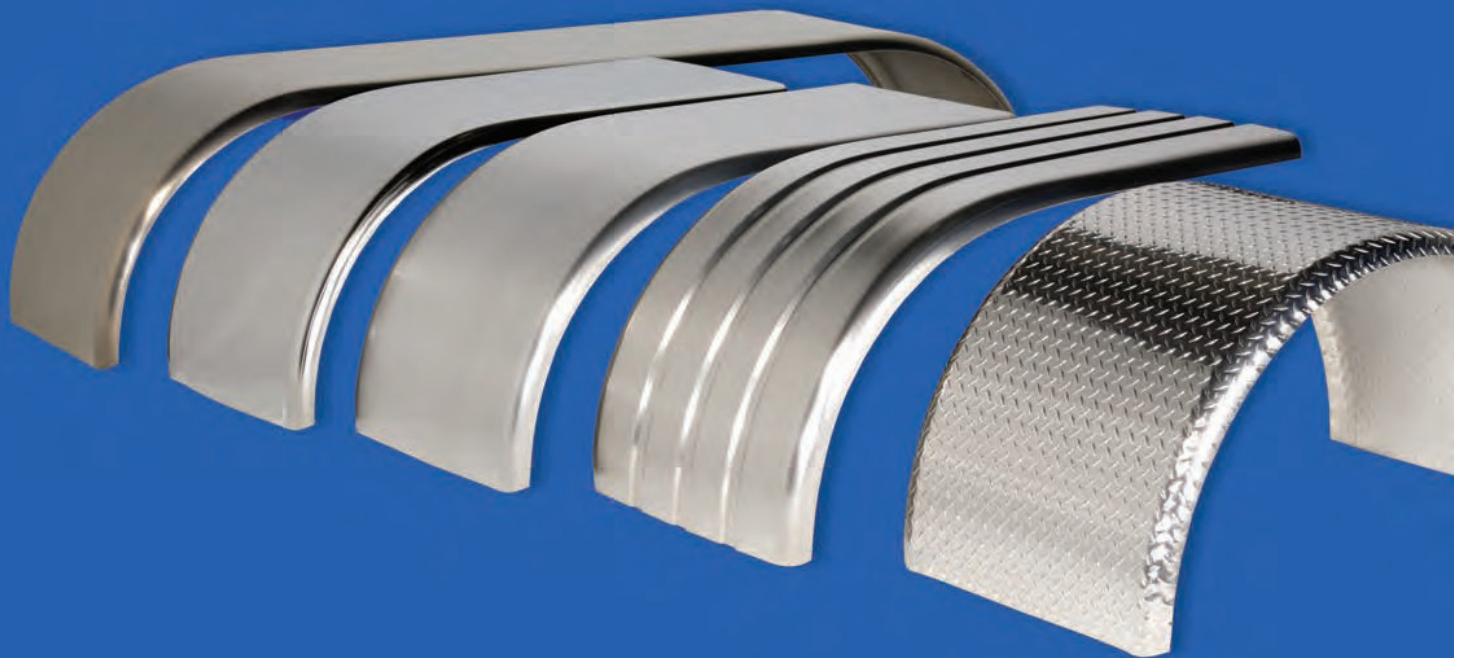

Rolled Fenders

ROLLED FENDERS

ORDER INFORMATION

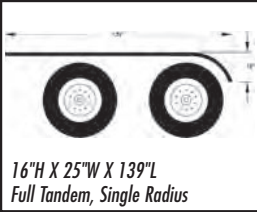
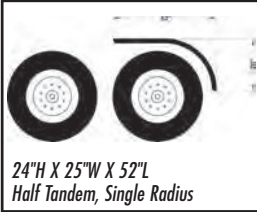
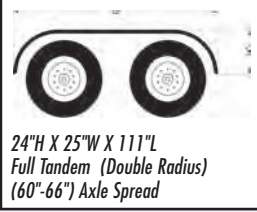
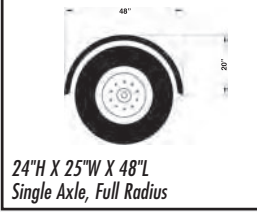
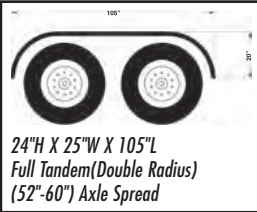
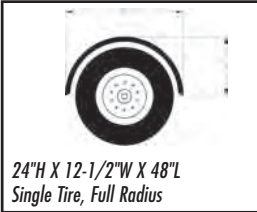
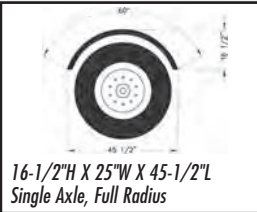
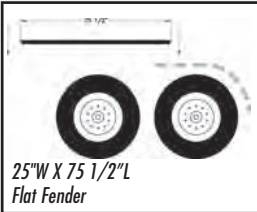
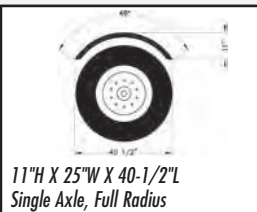
Order #	Description	Wt.	Order #	Description	Wt.
	5001 .090 Smooth Alum. W/ Ribs 35.4 5011 .090 Smooth Alum. 34.0 5021 .100 Diamond Plate Alum. 42.9 5031 .125 Smooth Alum. 47.1 5041 16 Gauge "Bright" S. S. 67.4			5000 .090 Smooth Alum. W/Ribs 15.6 5010 .090 Smooth Alum. 15.1 5020 .100 Diamond Plate Alum. 18.1 5030 .125 Smooth Alum. 21.0 5040 16 Gauge "Bright" S. S. 30.4	
	5002 .090 Smooth Alum. W/Ribs 33.0 5012 .090 Smooth Alum. 31.9 5022 .100 Diamond Plate Alum. 38.3 5032 .125 Smooth Alum. 44.2 5042 16 Gauge "Bright" S. S. 64.1			5004 .090 Smooth Alum. W/Ribs 18.3 5014 .090 Smooth Alum. 17.6 5024 .100 Diamond Plate Alum. 22.0 5034 .125 Smooth Alum. 24.3 5044 16 Gauge "Bright" S. S. 34.8	
	5003 .090 Smooth Alum. W/Ribs 32.2 5013 .090 Smooth Alum. 30.9 5023 .100 Diamond Plate Alum. 38.9 5033 .125 Smooth Alum. 42.7 5043 16 Gauge "Bright" S. S. 61.2			5005 .090 Smooth Alum. w/ Ribs 9.2	
	5037 .090 Smooth Alum. 14.0			5025 .090 Smooth Alum. with Ribs 18 5026 .090 Smooth Alum. 17.4 5027 .100 Diamond Plate Alum. 20.9 5028 .125 Smooth Alum. 24.1 5029 16 Gauge "Bright" S. S. 34.9	
	5035 .090 Smooth Alum. 11.1 5036 .125 Smooth Alum. 13.0				

FENDERS SOLD AS SINGLE UNITS, ORDER TWO FOR A SET. Fenders must be installed with Merritt brackets for warranty consideration.

CAUTION Fenders are not to be used as steps or load bearing surfaces. Note: Modifications of the fenders are at the discretion, responsibility, and risk of the installer.

Models and/or Specifications Subject to Change Without Notice.

F.O.B. - Fort Lupton CO, Sacramento CA, Salt Lake City UT, Dallas TX, Houston TX, Kansas City MO, Minneapolis MN, Atlanta GA, Pittsburgh PA, Calgary AB (CN), Toronto ON (CN)

Copyright © 2017 Merritt Aluminum Products Company. All Rights Reserved.

ALUMINUM PRODUCTS

1-800-525-0107

- ▲ Deep Fenders—New style fenders; Deep Drop Curved an addition 5" on the radius, which follows the tire radius. Deep Drop Straight with additional 5" added to the bottom of the radius—but continues straight down. Get that custom look at a standard price.
- ▲ Different styles and materials to choose from, allowing you to pick the "look" you want.
- ▲ Aluminum available in .090, .100DP or .125 thickness.
- ▲ 304 16ga stainless steel, #8 polish for strength and bright finish.
- ▲ Design a mounting style that will work for your truck.
- ▲ Super Duty models available for those rough applications.
- ▲ All Super Duty models are gusseted for added strength and long life.

DEEP DROP, SUPER DUTY FENDERS



Deep Drop Fenders

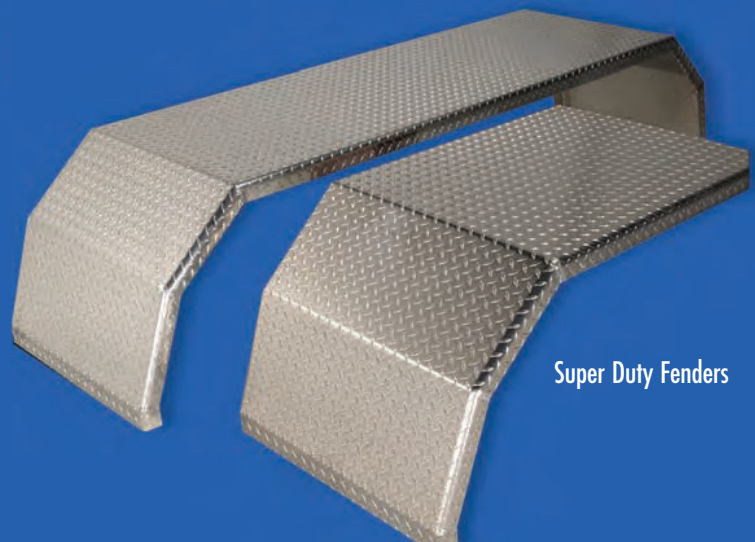



Super Duty Fenders

DEEP DROP ROLLED FENDERS

ORDER INFORMATION

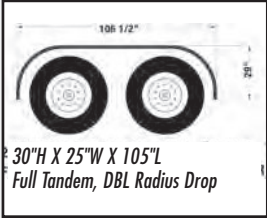
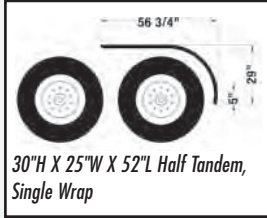
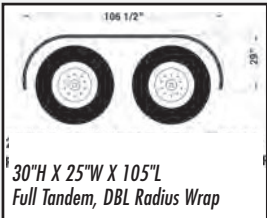
RADIUS WRAP AND DROP FENDERS

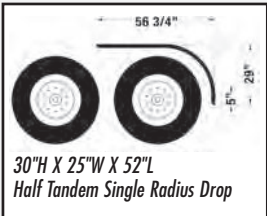
Order #	Description	Wt.	Order #	Description	Wt.
					
FENDER, FULL TANDEM DBL RADIUS DROP 30H X 25W X 105			FENDER, HALF TANDEM SNGL RADIUS WRAP 30H X 25W X 56 3/4		
5212	.090 Smooth Alum.	34.0	5211	.090 Smooth Alum.	15.1
5222	.100 Diamond Plate Alum.	42.9	5221	.100 Diamond Plate Alum.	18.1
5232	.125 Smooth Alum.	47.1	5231	.125 Smooth Alum.	21.0
					
FENDER, FULL TANDEM DBL RADIUS WRAP 30H X 25W X 105			FENDER, SNGL AXLE RADIUS WRAP 30H X 25W X 48		
5213	.090 Smooth Alum.	31.9	5214	.090 Smooth Alum.	17.6
5223	.100 Diamond Plate Alum.	38.3	5224	.100 Diamond Plate Alum.	22.0
5233	.125 Smooth Alum.	44.2	5234	.125 Smooth Alum.	24.3
5243	16 Gauge 304 S. S.	64.1	5244	16 Gauge 304 S. S.	34.8
					
FENDER, HALF TANDEM SNGL RADIUS DROP 30H X 25W X 52					
5210	.090 Smooth Alum.	30.9			
5220	.100 Diamond Plate Alum.	38.9			
5230	.125 Smooth Alum.	42.7			

FENDERS SOLD AS SINGLE UNITS, ORDER TWO FOR A SET. Fenders must be installed with Merritt brackets for warranty consideration.

CAUTION Fenders are not to be used as steps or load bearing surfaces. Note: Modifications of the fenders are at the discretion, responsibility, and risk of the installer.

SUPER DUTY FENDERS

Order #	Description	Wt.
179	Full Fender, Tandem Axle 52" to 60"	54
180	Full Fender, Tandem Axle 60" to 66"	59
177	Half Fender	25

(fenders sold as single units, order two for a set)

- ▲ Extra strong design, made of 1/8" thick, diamond plate aluminum alloy, designed with a double break and reinforcing gussets, allowing for added strength and longer life!
- ▲ Bright, diamond plate finish - keeps looking good, even in hard use!
- ▲ Half fenders have the same strong design and material specifications as the full fenders!

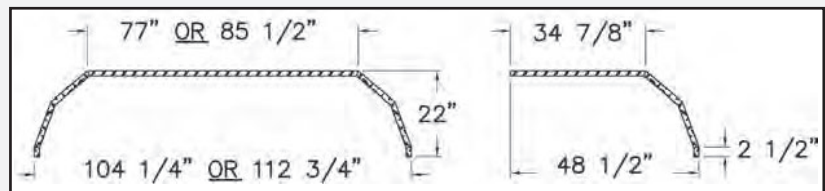
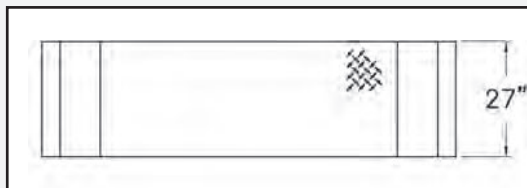

Models and/or Specifications Subject to Change Without Notice.

F.O.B. - Fort Lupton CO, Sacramento CA, Salt Lake City UT, Dallas TX, Houston TX, Kansas City MO, Minneapolis MN, Atlanta GA, Pittsburgh PA, Calgary AB (CN), Toronto ON (CN)

Copyright © 2017 Merritt Aluminum Products Company. All Rights Reserved.

ALUMINUM PRODUCTS
MERRITT
 1-800-525-0107

- ▲ Heavy Duty, HDPE-High Density Polyethylene Flexible, W/UV Protection
- ▲ Packaged as sets-two fenders per package
- ▲ Full Fender is bolted together in the middle

- ▲ Currently six models available:
 - Half, Single Radius/Super Single
 - Full, Double Radius/Super Single
 - Full Single Axel, Full Radius/SS
- ▲ Very flexible, low damage fender. Low cost - long life

- ▲ Stocked in our warehouse group for fast and economical delivery
- ▲ Use our market tested and easy to install "E-Z Mount" brackets to mount the Poly-Pro fender
- ▲ Standard Fender is 25" Wide Super Single Fender is 18" Wide

"POLY-PRO" POLYETHYLENE / SUPER SINGLE FENDERS

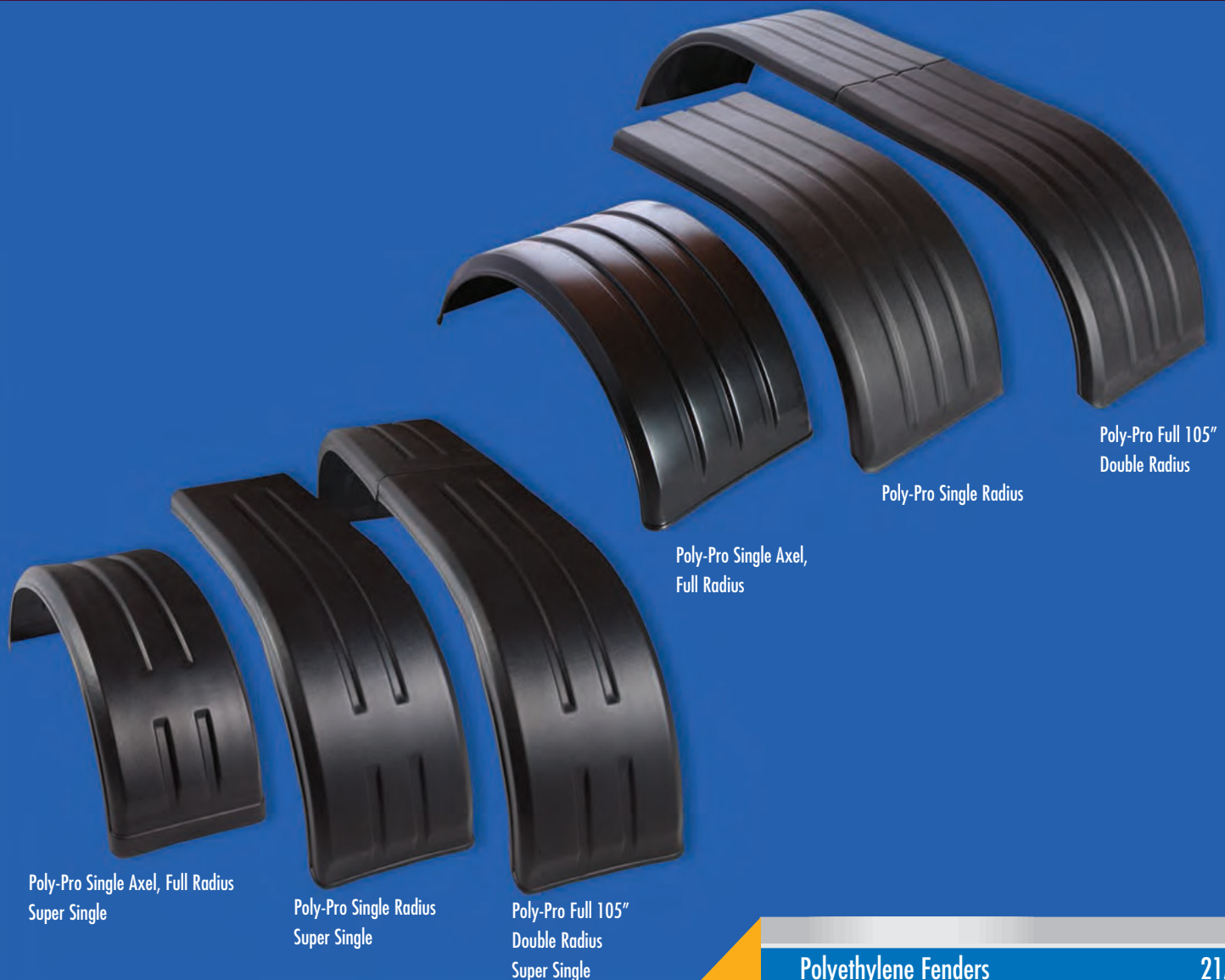

Poly-Pro Full 105" Double Radius

Poly-Pro Single Radius

Poly-Pro Single Axel, Full Radius

Poly-Pro Single Axel, Full Radius Super Single

Poly-Pro Single Radius Super Single

Poly-Pro Full 105" Double Radius Super Single

"Poly-Pro" POLYETHYLENE FENDERS

ORDER INFORMATION

POLYETHYLENE FENDERS

Order #	Description	Shipping Wt.
5344-2	Poly-Pro Single Axle, Full Radius High Density Polyethylene, Black Non-Paintable Set of Two Ribbed	20 lbs
5340-2	Poly-Pro Half Tandem Fender, Single Radius High Density Polyethylene, Black Non-Paintable Set of Two Ribbed	20 lbs
5343-2	Poly-Pro Full Tandem Fender, Double Radius High Density Polyethylene, Black Non-Paintable Set of Two Ribbed Consists of: 4-Half Fenders / 1-Nut & Bolt Package	45 lbs



SUPER SINGLE POLYETHYLENE FENDERS

Order #	Description	Shipping Wt.
5345-2	Poly-Pro Single Axle, 18" wide Full Radius High Density Polyethylene, Black Non-Paintable Set of Two Ribbed	20 lbs
5346-2	Poly-Pro Half Tandem Fender, 18" wide Single Radius High Density Polyethylene, Black Non-Paintable Set of Two Ribbed	20 lbs
5347-2	Poly-Pro Full Tandem Fender, 18" wide Double Radius High Density Polyethylene, Black Non-Paintable Set of Two Ribbed Consists of: 4-Half Fenders / 1-Nut & Bolt Package	45 lbs

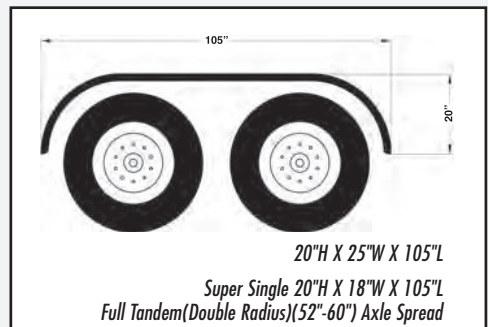
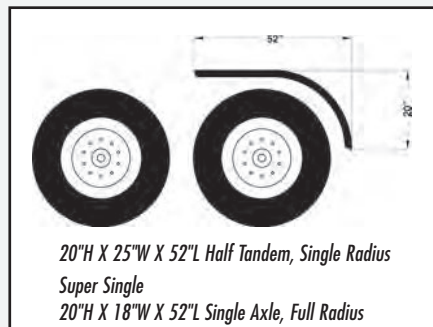
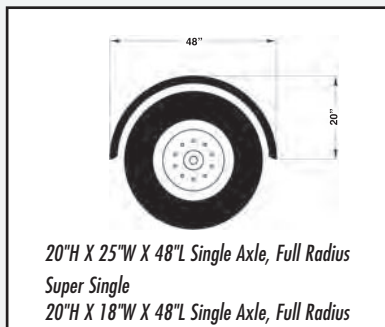

Models and/or Specifications Subject to Change Without Notice.

F.O.B. - Fort Lupton CO, Sacramento CA, Salt Lake City UT, Dallas TX, Houston TX, Kansas City MO, Minneapolis MN, Atlanta GA, Pittsburgh PA, Calgary AB (CN), Toronto ON (CN)

